

# Bioengineers and incubators

## Setting the Scene

You will be working as a member of a research team in a university bioengineering department. Your department is about to put forward a research proposal to obtain money to develop incubators for very premature babies. You will be asked to carry out research in this area and write part of the proposal for the research grant.

## Pupil Research Brief

### Study Guide

#### Syllabus Targets *Science you will learn about in this Brief*

- the thermoregulatory centre of the brain monitors and controls body temperature
- this centre has receptors sensitive to the temperature of the blood flowing through the brain
- temperature sensors in the skin send impulses to the centre
- if the body temperature is too high, blood vessels in the skin dilate so that more blood flows near to the surface and more heat is lost
- sweat glands release sweat which evaporates to cool the body
- if the body temperature is too low blood vessels supplying the skin constrict to move blood flow deeper into the skin
- when muscles 'shiver', the extra respiration releases some energy as heat

#### Route through the Brief

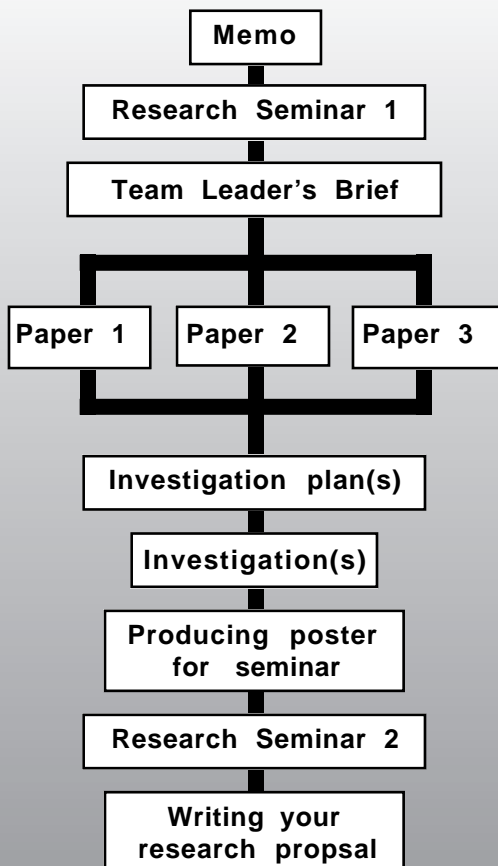

#### Outcome Checklist

You will carry out research into one aspect of incubator design, and present a report of your findings to a research seminar. Following the seminar you will write a research proposal. You should make sure you produce the following items as you work through the Brief.

##### Research Seminar 1

- notes on information covered by the seminar

##### Scientific papers

- notes on points raised by handwritten comments

##### Group discussion

- investigation plan

##### Investigation(s)

- written report and poster for presentation at Research Seminar 2
- materials for presentation

##### Research Seminar 2

- notes on information covered by the seminar
- research proposal outlining recommendations for the design of a new incubator

# Department of Bioengineering

## Memo from the Office of the Research Director

To: Research Teams

Date:

**Subject:** Research proposal: Incubators for very premature babies

I am sure you will have noticed recent dramatic cases of premature babies surviving from very early stages of development. I have attached a newspaper cutting of one such case to the bottom of this memo. These are part of a long-term trend. Medics can save babies at earlier and earlier stages, when homeostatic processes such as temperature control are not fully developed. The problems often begin after birth when the incubator technology is not of the highest quality or sophistication.

I suggest that we should carry out further research in the area of temperature control and incubator technology prior to submitting a proposal for a research grant.

To help teams start work there will be a research seminar on "Temperature Control in Humans" in the lab conference room next week. I expect all researchers to attend.

At the end of the seminar I will provide a briefing sheet and research paper, with suggestions for further research, for each of our team leaders.

I look forward to seeing you at the seminar.

# Memo

3 May 1991

## Belfast Telegraph

### Double victory with miracle babies!

In a dramatic announcement earlier today Professor Halliday of the Royal Maternity Hospital Neonatal Unit announced that a baby, one of the smallest babies ever born in the Province, was now stable following her premature birth yesterday morning. The little girl weighed in at just 485 grams and measured only 29 cm. Amazingly her brother, born a year ago, weighed in at 465 grams and also survived. A normal term baby weighs 3,500 grams with a body length of 50 cm.

Doctors are now working to keep the baby alive for the first few critical days. Their main concern is that the baby cannot control her own body temperature accurately. The mechanisms that do this in adults are often poorly developed in premature babies.

## Research Proposal: incubators for very premature babies

### Team leader's brief

At our recent meeting we agreed to seek funding for a research project leading to the development of an incubator for very premature babies. To enable us to submit a research proposal we will have to follow up our previous work with further research. I have allocated a scientific paper to each of our teams, with suggestions for further research tasks.

**Team A** - Paper 1 "Determining the normal temperature range in humans"

**Team B** - Paper 2 "The need for a mechanical device to control temperature"

**Team C** - Paper 3 "Keeping babies warm"

### Research tasks for each team

1. Read through your research paper and deal with the points I've written by hand on the paper.
2. After you have completed the paper, discuss how you could investigate the factors indicated for investigation by your team.
3. Produce an investigation plan (or plans), which I would like to look over first.
4. Once the team plan has been accepted, carry out your team investigation.
5. Produce a research report on your investigation and a poster summarising your research for display at the next research seminar (see presentation guidance on next page). The sections of the report should be:
  - title
  - introduction to your research
  - scientific background
  - how your research will improve premature baby care
  - introduction to your investigation (question, hypothesis, and predictions)
  - your method
  - results (graphs and tables)
  - discussion of your results
  - summary of your findings
  - suggestions for incubator design resulting from your research (using diagrams)
  - ideas for further research.

## Team leader's brief continued

### Guidance for preparing your presentation at the research seminar

1. Write your report in the way I have described above.
2. Summarise each component of your report clearly and visually in bullet-point form on poster paper and possibly an overhead projector transparency. Make sure your poster has a title, the names of all the group (surname plus initials) and the date in years.
3. Write a script to go with each component which emphasises the key points.
4. Decide who is going to present each component.
5. Practice the presentation until you are confident that it will be effective.

### Writing the research proposal

Following the second research seminar you should write a research proposal based on your research work and that of other groups presented at the seminar. You should write the report based on the following format.

#### Section 1 Why the research should be carried out.

1. Introduce the research topic, in one or two sentences, include title, what research we have recently been carrying out, and what we hope to achieve.
2. Explain the scientific and medical background to this topic, using 100 words maximum. Include brief notes on temperature control in humans and the problems premature babies have.
3. Explain how the results of our research will help to improve premature baby care, in a maximum of 100 words.

#### Section 2 Outline of previous research and track record.

Write a brief report of your investigations here, including title, questions, hypotheses and predictions (if appropriate), your method, your results in the form of tables and graphs, a discussion and summary of your (and other groups') findings.

#### Section 3 The plan for the research programme.

Describe in detail, using diagrams where appropriate, how these research findings could be helpful in the design of an incubator. Write your ideas for further research you would like to carry out which could help with the design of a new incubator.

N.B. Where you refer to the work of other groups in your report, you should indicate this by writing the *name* and *year* of the work you quote, eg.. *Smith, J.(1996)*. At the end of your report, list all such references alphabetically, but this time also include the title, eg. *Smith, J. (1996) Incubator design*.

## Paper 1

From unpublished research material by Ms Z. McCreech, Northern Ireland Bioengineering Centre, University of Ulster 1995. I suggest you work through this paper in your research team. I have written notes to help you. You will need to carry out an investigation to follow it up. I have made some suggestions.

# Determining the normal temperature range in humans

*This section provides useful background information for your investigation and could help you to write the section on scientific background for your research report.*

Humans maintain a constant body temperature of about 37°C. Many parts of the body help to maintain this constant temperature. Illness caused by a disease is not only due to the presence of the microorganisms in the body, but also to the increased temperature which results from their activities in the body. If our temperature rises much above 42°C (a condition called hyperthermia) death occurs.

A constant temperature of about 37°C is needed for the special proteins called enzymes to work efficiently. Enzymes help the cells of the body to function. Most enzymes are destroyed at temperatures much above 40°C. The brain is one of the first organs to be affected. An abnormally low body temperature (hypothermia) can also be serious. It slows down important chemical reactions in the body and can disrupt brain function. It is therefore very important to determine the normal temperature range in humans and keep babies within this range.

A premature baby has difficulty maintaining its body temperature and easily becomes cold. Hypothermic babies are more likely to die or to develop a serious illness. It is therefore important that we are able to accurately measure and regularly monitor the temperature of a premature baby.

*The next section should provide you with some ideas for measuring body temperature*

## Measuring temperature

Body temperature can be measured using mercury-in-glass or alcohol-in-glass **medical thermometers**, disposable “dot” thermometers, **bead thermistors** or **infrared sensors**. The accuracy normally required is  $\pm 0.1^\circ\text{C}$ .

The accuracy of infrared sensors varies with the angle at which they are held, the distance from the patient and the flatness of the skin surface. Mercury thermometers can be hard to read. For readings taken in the mouth they have to be left in for 7 minutes to be fully accurate. Bead thermistors are very accurate and have a fast response time but can only be read when connected to a digital read-out or datalogger.

For our research project we decided to use disposable dot thermometers. This avoided worry about sterilising procedures, but they are very easily influenced by room temperature.

Figure 1. Disposable dot thermometer reading 37.1°C

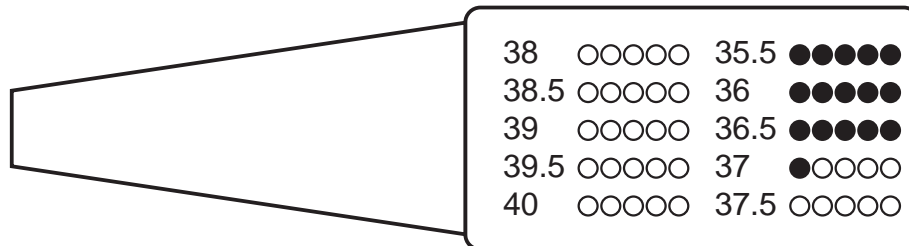

The disposable dot thermometer was placed under the tongue of one individual and a temperature of 37.1°C was recorded. Body temperature varies from person to person, and in the same person it changes with the time of day, exercise, smoking, eating and drinking. In women temperature can vary in step with the menstrual cycle. Temperatures also vary widely between the core areas inside the body (around the heart, lungs and liver) and different skin areas. As with other single measurements, the result is useful as an indicator but does not necessarily give an accurate value. This could be a freak result. For it to be reliable I would have to repeat it several times and then calculate the average result.

### Other techniques

Luckily there were enough people in the research team to try another approach - small group measurement. We took everyone's temperature and obtained the following results.

Figure 2. Oral temperatures of team members

Team member	Mouth temperature [°C]
John	36.7
Joe	37.1
Sue	36.5
Ann	36.9
Emmet	36.8
John M	37.2
Paul	37.4
Kay	37.0
Mike	36.9
Marie	36.6

Find out what techniques are available for you to measure body temperature. Practice using the technique by measuring your body temperature. Use several techniques, including a computer sensor.

The following page describes how we can use measurements and mathematical techniques to determine the normal temperature range in humans. Ask me for advice, if you require it.

Paper 1 continued

To see a pattern in the numbers we need to use a mathematical technique called a **frequency graph**. This can be produced by taking the following steps.

First take the lowest number (36.5) and the highest (37.4) and pick a sensible number of equal sized steps to cover all the numbers with no gaps or overlaps.

- 36.4 - 36.5
- 36.6 - 36.7
- 36.8 - 36.9
- 37.0 - 37.1
- 37.2 - 37.3
- 37.4 - 37.5

Use this to do a tally chart i.e. work out the number of temperature readings which fall into each of the ranges. The tally chart (Figure 3) can then be used to draw a graph (Figure 4).

Figure 3. Oral temperatures tally chart

Temperature range °C	Tally
36.4 - 36.5	1
36.6 - 36.7	2
36.8 - 36.9	3
37.0 - 37.1	2
37.2 - 37.3	1
37.4 - 37.5	1

Small group measurements are useful with frequency graphs in showing patterns. The small-scale experiment gives us a rough idea of the range of temperatures in healthy people and it also shows a partial outline of a pattern called the normal distribution curve. This occurs with many biological variables, with most measures grouped around a central average and two tails either side with a minority of higher and lower measures.

Figure 4. Oral temperatures frequency distribution graph

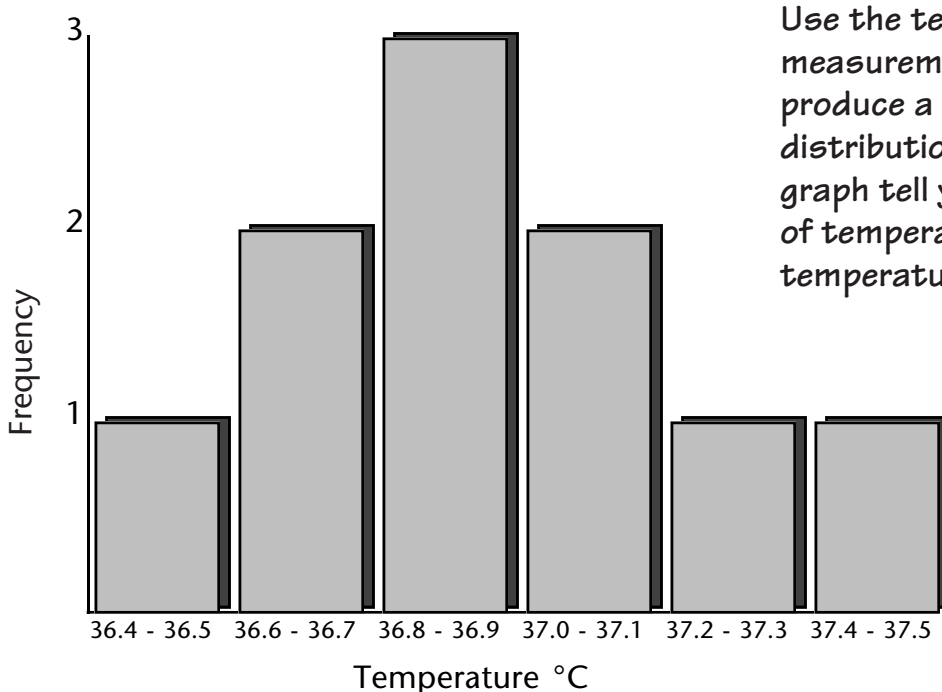

Use the temperature measurements of your team to produce a tally chart and frequency distribution graph. What does your graph tell you? What was the range of temperature and average temperature?

## Paper 1 continued

This technique can give us a picture of the human temperature range and the “normal” temperature. However, we need more data to provide a more accurate and detailed picture. The more data we collect the more reliable the evidence, and so frequency graphs with thousands or tens of thousands of data points are not uncommon.

### **Note:**

Numbers and graphs often intimidate people into believing that they are completely correct. We need to be sensitive when quoting figures!

### **Recent research**

Information about temperature ranges has been known for some time. Researchers are now investigating the following :

- convenient and accurate sensors that can be permanently attached to the body
- computer software that can analyse patterns in changes
- long-range systems that would allow doctors to diagnose over the telephone line!

*I suggest you carry out investigations to answer the following questions for the purpose of our research project:*

*Use your group sample to find out what the normal body temperature range is in humans (use as large a sample as possible).*

*Where on a baby’s body could we semi-permanently attach a sensor which would accurately reflect changes in core temperature? A sensor could not be permanently placed in the mouth or rectum. It has to be comfortable for the baby.*

*(Select volunteers from your team and record core and skin temperatures from different parts of the body while they are resting. The volunteers should then do 5 minutes exercise or sit in a warm place to raise the body temperature.*

*Temperature can be recorded at regular intervals if the thermometers are read quickly. You could use temperature sensors . The sensor probe can be placed on the skin, covered with a piece of aluminium foil to prevent heat loss and then taped in place. For this - see me for advice. This investigation should enable you to identify which area of the skin continues to be most closely similar to the core temperature).*

*Remember to be as accurate in your techniques as possible.*

*You will need to summarise the methods, results tables and graphs, and conclusions of these investigations in your research report for presentation at the research seminar. Please refer to your team research tasks for more detail. In your report remember to show diagrammatically how your probe would be used to monitor baby temperature in the incubator.*



# The need for a mechanical device to control temperature

This paper, based on 'Thermal control in very immature infants' by D. Hull, British Medical Bulletin, vol. 8, p.67, 1994, outlines some of the causes of heat loss in premature babies and why incubators are needed. It will help you write the scientific background information to your research report. I suggest you work through it in your research team. You will need to carry out an investigation to follow it up. I have made some suggestions in the paper. I have also made suggestions for further work at the end of the paper.

A series of reviews in the British Medical Bulletin have shown that full term babies have a full range of temperature control systems. These are of limited capacity and may need to adjust to the environment that the baby finds itself in.

Babies born more than 12 weeks prematurely present a very different problem. They have difficulty maintaining their body temperature and easily become cold. They are unable to warm themselves by shivering. Their deposits of brown fat are also smaller. Brown fat is situated in



Figure 1. Brown fat deposits in a baby (shaded areas)

the neck and abdomen and is a source of energy which can keep the body warm. Premature babies are not just smaller versions of larger babies, the proportion of their body sizes may be different. Small babies also have a higher surface area to volume ratio than larger babies. However their body temperature should be the same.

The problems do not end there. The skin is not fully formed, it is just a few cells thick. Also the protein keratin which makes skin watertight will not form fully for 3 or 4 days. The premature baby can lose a lot of water through the skin.

**You could investigate the effect of body size, and surface area to volume ratio on the rate of heat loss (actually, this is the transfer of heat to the environment) by using different sized flasks of hot water and recording the temperature of the water over a period of time. Premature babies tend to be thinner and longer in shape than full term babies. How could this affect the surface area to volume ratio and so the rate of heat loss?**

**You can also investigate the effect of body proportions on heat loss by using a spread sheet. Please see me for further information.**

## Paper 2 continued

Babies born 12-16 weeks early do not increase heat production as the temperature falls below 36.5°C and babies more than 8 weeks early do not sweat in the first 7 days of birth.

It is clear that it is not feasible to look to the baby's own temperature control mechanism to preserve its life. We need a mechanical device, i.e. an incubator, that can copy and replace the natural systems.

Fortunately premature babies do not seem to suffer seriously from over-heating. So, incubator design only needs to ensure that their temperatures do not fall below a certain value. Many researchers have reported better survival rates when the rectal temperature is kept above 36°C.

You could investigate the effect of the evaporation of water from the baby's skin on its body temperature using two thermometers or temperature probes. Set up the apparatus as shown in my diagram. Start recording the temperature and then add a few drops of water to the cotton wool on the first probe or thermometer. Keep recording until the temperature stops changing.

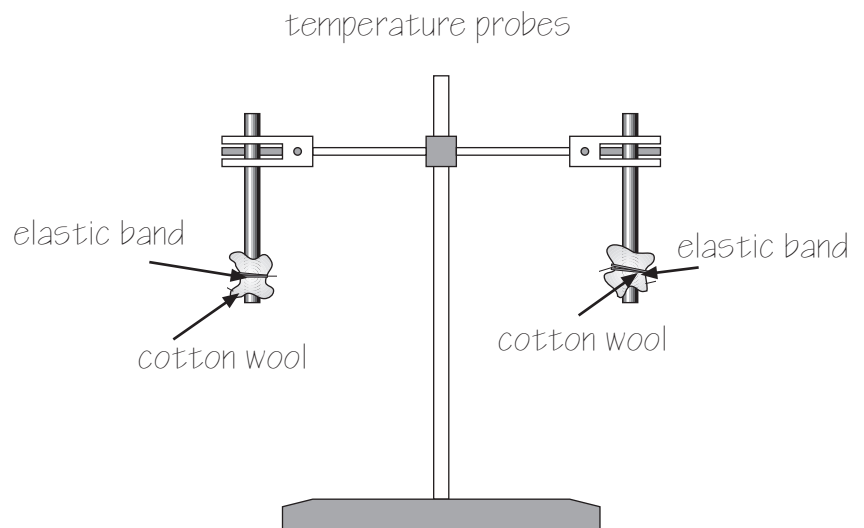

You will need to summarise the methods, results tables, graphs and conclusions of your investigations in your research report for presentation at the research seminar. Please refer to your research tasks on the team leader's tasks for more detail.

Use your findings from this paper and your investigations to make suggestions for how these problems could be addressed by your suggestions for incubator design. Use diagrams to help show these features.

## Paper 3

This paper, from 'Recent advances in perinatal medicine', by D. Hull and G. Chellappah, Vol. 6, p. 89 - 94, (1995), describes research on the links between metabolic factors affecting body temperature and the rate of sweating. I suggest you work through this paper in your research team. I have made notes to help you. You will need to carry out an investigation to follow it up. I have made some suggestions.

# Keeping babies warm

Pierre Budin, in his book *The Nursling* (1907) showed that if the internal temperature of premature babies (measured at the rectum) was maintained their survival rates were dramatically increased.

A summary of his results below showed the important relationship between rectal temperature and survival.

Rectal temperature[°C]	Survival rate
32.5 - 33.5	10%
36.0 - 37.0	77%

Budin's results were largely ignored for over 40 years. In the 1950s and '60s his work was rediscovered by a number of researchers.

### Neutral thermal environment

These researchers discovered that for each baby there is an ideal range of environmental temperature. If kept within this range the baby uses the least possible amount of oxygen and heat energy released during respiration to keep its body temperature normal. This temperature range is known as the **neutral thermal environment**. For a small naked baby the range is very narrow.

*Describe this in your own words in your report as part of the scientific background section*

Glass et al (1968) showed that the rate of increase in body mass of a baby was significantly faster in a neutral thermal environment. It is now known that the control of the body temperature of a premature baby is critical. Mestyan et al (1964) found the neutral thermal environment for babies having masses of 1.5 - 2 kg was at least 34.5° C and for under 1.5 kg it was 36° C. The aim should be to keep the skin temperature at 36.5° C +/-0.3° C. Figure 1 below illustrates this.

# Paper 3 continued

At the dotted lines no readings were taken. These measures come from animal experiments. It is illegal and unethical to carry out medical experiments that might harm a patient.

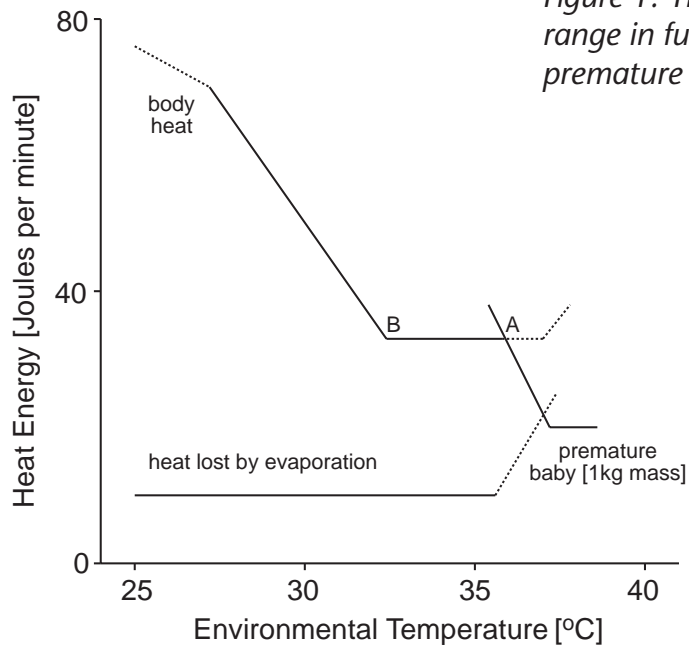
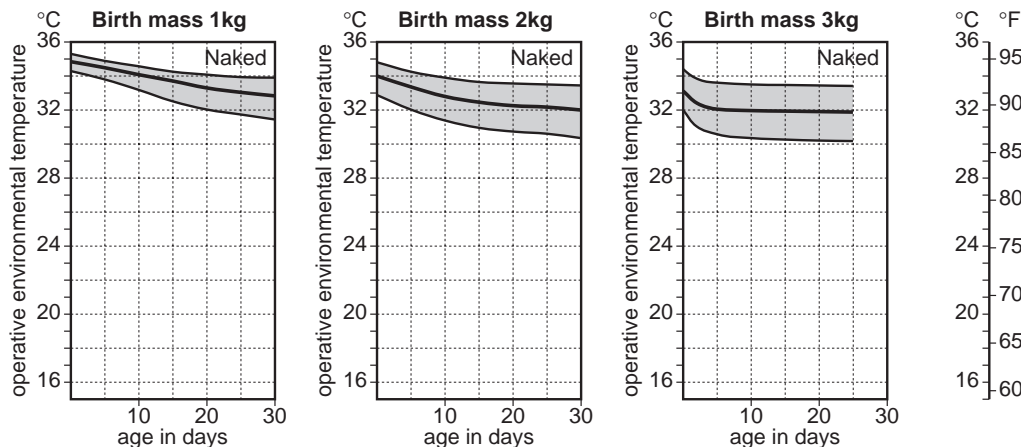

Figure 1: Thermoneutral range in full term and premature babies

The line AB is the neutral thermal environment. At B the amount of energy the baby needs to keep warm is at a minimum. At A it will need extra energy to sweat and stay cool. The width of the line AB depends mostly on the ability of the baby's body to control temperature loss.

Hey (1971) produced a table of neutral thermal environment values (see Figure 2) for babies of different masses and ages to assist with their care in incubators. From this graph doctors can identify the appropriate range of temperatures for the baby. This has proved very useful. The work was based on identifying point B. Unfortunately the guidelines tend to break down when dealing with sick and very premature infants. Premature babies under 34 weeks do not sweat, although in the first days leakage of water through the undeveloped skin threatens the survival of the baby (Hull, 1995).

Figure 2: Neutral thermal environments and birth masses



## Paper 3 continued

When a baby is naked in an incubator, it transfers heat energy by radiation and convection to the air inside, and the hood of the incubator. The hood in turn also transfers heat energy to the air, ceiling, walls, windows and objects within the room, by convection and radiation. Very little energy transfer occurs by conduction.

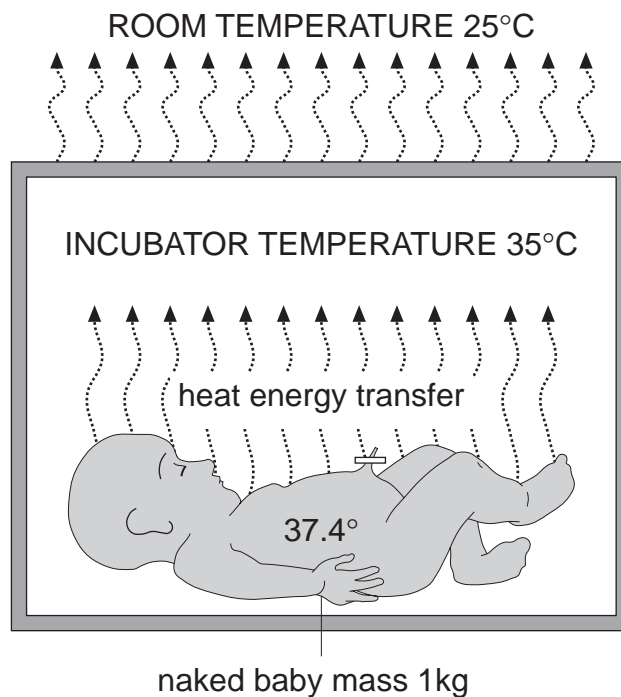

Figure 3: Heat transfer between a baby, the incubator and the environment

### References

- Glass, L., Silverman, W. A. & Sinclair, J. C (1968). *Pediatrics*, 41, 1033.  
Hey, E. (1971) Recent Advances in Pediatrics, 4th Edition edited by Gairdner and Hull. Churchill, London.  
Hull, D. (1995) Thermal Control in very Immature Infants, *British Medical Bulletin*  
Mestyan, J., Fekete, M., Bata, G. & Jarai, I. (1964). *Biol. Neonat. (Basel)*, 7, 11.

I've copied this - see Paper 2

Investigate heat energy transfer by radiation and convection between the baby, the incubator and the external environment and methods of reducing this heat loss. Do this by producing a simple model to represent the baby and incubator. You could use temperature probes to monitor temperature changes. See me for advice.

How could you monitor and control temperature in the incubator to ensure a neutral thermal environment and the desired constant body temperature? Draw diagrams to help illustrate your ideas. These could be used in the suggestions for incubator design section of your research report.

I would suggest you write a brief report of your research including questions, hypotheses, prediction, method, results, discussion and summary of findings to present at the research seminar. How could it influence our future research? Make